

Operating Guide

VM2, VB2 DN 15-50

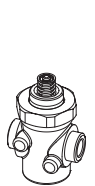

MAINTENANCE
FREE



VM 2
(DN15-50)

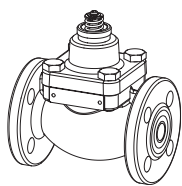

VB 2
(DN15-50)

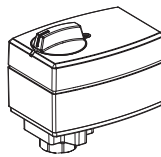

AMV(E) 10, 13



$T \leq 130^{\circ}\text{C}$

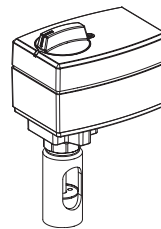

AMV(E) 10, 13
+ adapter **065Z7547**



$130^{\circ}\text{C} < T \leq 150^{\circ}\text{C}$

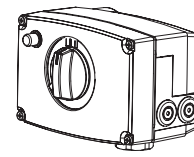

AMV(E) 20, 23, 30, 33



$T \leq 150^{\circ}\text{C}$

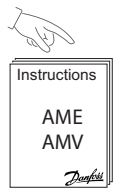

Instructions
AME
AMV
Danfoss

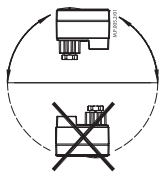

IP54
AMV(E) 10, 13

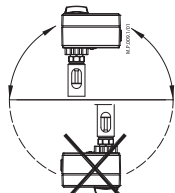

IP54
AMV(E) 10, 13 + adapter

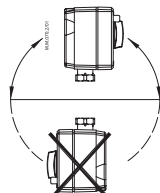

IP54
AMV(E) 20, 23, 30, 33

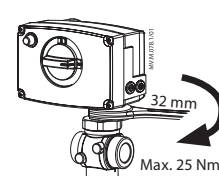

Max. 25 Nm

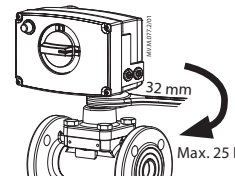

Max. 25 Nm

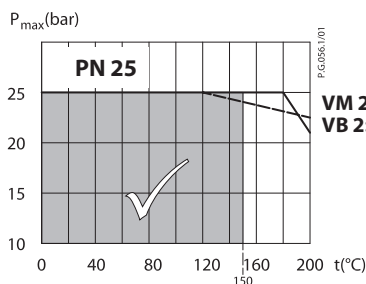
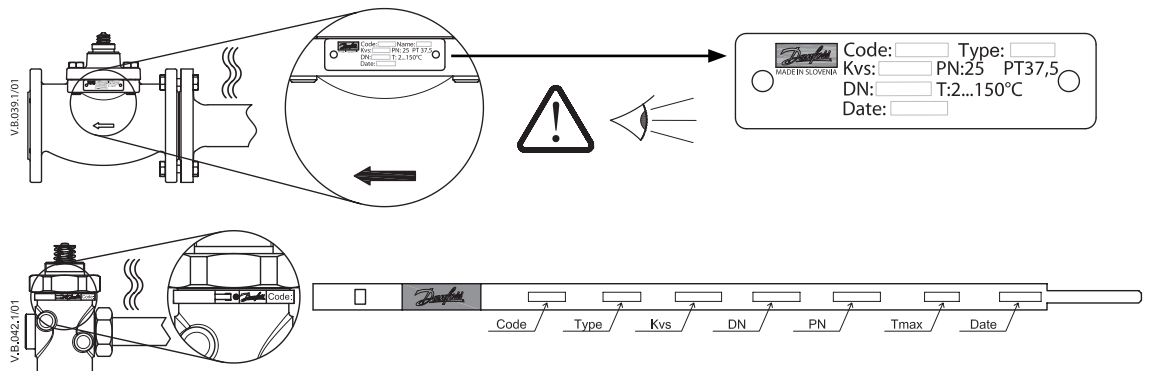

VM2, VB2

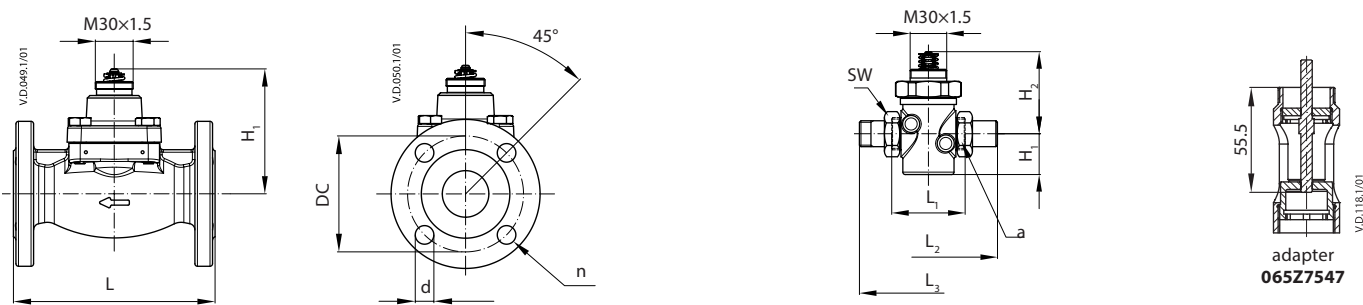
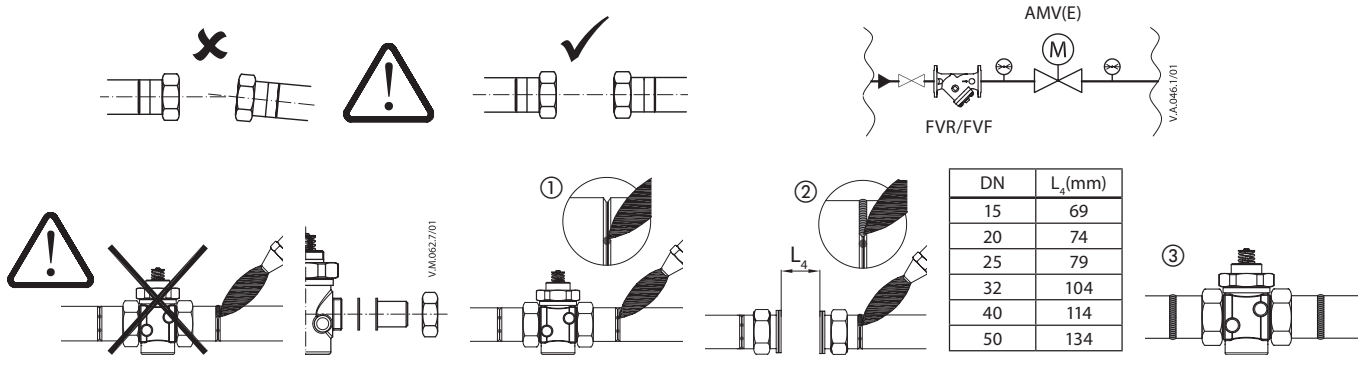

VB 2

DN	H ₁	L	DC	d	n	Weight (kg)
15	99	130	65	14	4	3.40
20	99	150	75	14	4	4.23
25	99	160	85	14	4	4.65
32	123	180	100	18	4	8.40
40	123	200	110	18	4	9.24
50	123	230	125	18	4	10.91

VM 2

DN	H ₁	H ₂	L	L ₂	L ₃	SW	a		Weight (kg)
							ISO 228/1		
15	33	70	65	139	120	30	G ¾A		0.80
20	33	70	70	154	131	37	G 1A		0.83
25	38	70	75	159	145	46	G 1¼A		0.98
32	38	70	100	184	177	63	G 1½A		1.18
							G 1¾A		1.22
40	38	88	110	244	200	64	G 2A		2.34
50	44	88	130	298	244	81	G 2½A		3.25

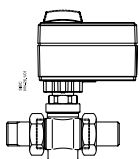

AMV(E) 10, AMV(E) 13
VM2 DN 15 - 32

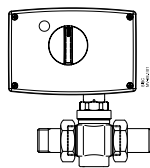

AMV(E) 20, 30; AMV(E) 23, 33
VM2 DN 15 - 50

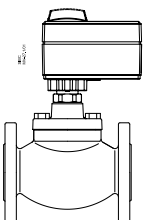

AMV(E) 10, AMV(E) 13
VB2 DN 15 - 25

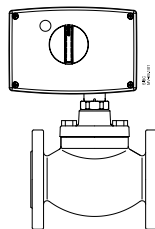

AMV(E) 20, 30; AMV(E) 23, 33
VB2 DN 15 - 50

Type	DN	k _{vs} (m³/h)	AMV(E) 10/13	AMV(E) 20/23; AMV(E) 30/33
VM 2	15	0.25-4.0	✓	✓
	20	4.0	✓	✓
	20	6.3	✓	✓
	25	6.3-8.0	✓	✓
	32	10	✓	✓
	40	16	✗	✓
50	25	✗	✓	

Type	DN	k _{vs} (m³/h)	AMV(E) 10/13	AMV(E) 20/23; AMV(E) 30/33
VB 2	15-25	0.25-10	✓	✓
	32-50	16-40	✗	✓

Danfoss can accept no responsibility for possible errors in catalogs, brochures and other printed material. Danfoss reserves the right to alter its products without notice. This also applies to products already on order provided that such alterations can be made without subsequent changes being necessary in specifications already agreed. All trademarks in this material are property of the respective companies. Danfoss and the Danfoss logotype are trademarks of Danfoss A/S. All rights reserved.